

Data Sheet



Article number: 0118019

Description: Retaining ring H 7

Measures

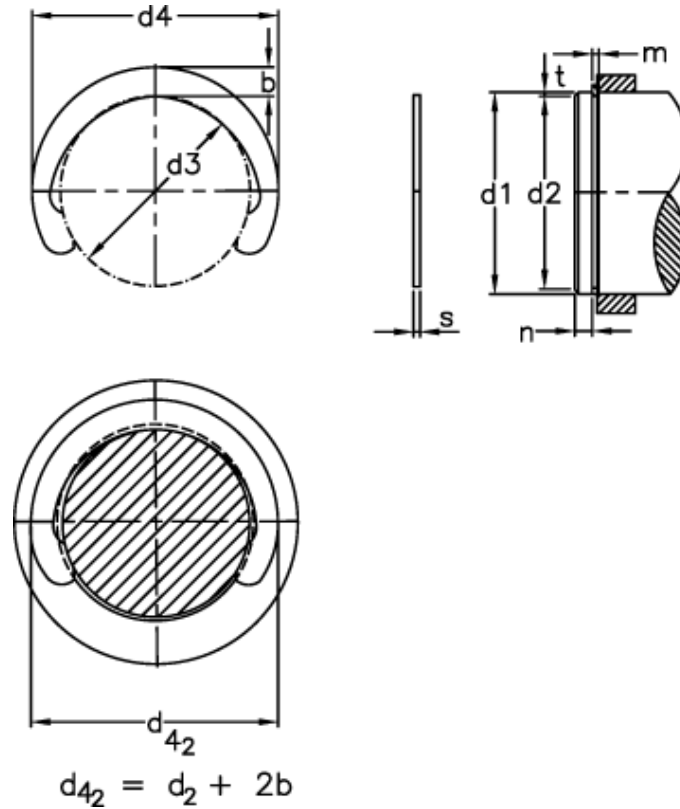

b	= 1.40	FRg kN	= 1.3	t	= 0.50
d1	= 7	FR kN	= 2.20	tol	= -0.09
d2	= 6.0	g	= 0.80	tol	= 0.08
d3	= 5.80	Gripper	= GRH 7	tol	= -0.05
d4	= 8.60	m min	= 0.85	Weight kg/1000	= 0.13
d4 2	= 8.8	n abl x 1000	= 69		
Description = H 7,0		Nominal drive	= 1.5		
FN kN	= 0.85	s	= 0.80		